



MOB-729

USER MANUAL

CONTENTS

1.	BASIC INFORMATION	4
1.1	ABOUT THE MANUAL	4
1.2	COPYRIGHTS	4
1.3	ICONS	4
2.	IMPORTANT SAFETY CONSIDERATIONS	5
2.1	GENERAL INFORMATION	5
2.2	CHECKING	5
2.3	STORAGE	5
2.4	INSTALLATION AND USE	5
2.5	NOTES AND WARNINGS.....	6
2.5.1	Electrostatic discharge.....	6
2.5.2	Radiation.....	6
2.5.3	Fiber optic cables.....	7
2.6	MODIFICATIONS	7
3.	GENERAL INFORMATION	8
3.1	INTRODUCTION	8
3.2	FEATURES OF THE MOB-729	8
3.3	BLOCK DIAGRAM	9
3.4	FUNCTIONAL UNITS	10
3.5	POWER UNIT.....	11
3.5.1	Fuse.....	11
3.6	PLUG-IN MODULES	11
3.6.1	C-729 local monitoring module	11
3.6.2	M-729 remote monitoring module	12
3.6.3	JMP/1 – jumper module	13
3.6.4	STI-3,5	13
3.6.5	TSI 2/6, TSI 1/9, TSI 1/12, TSI 1/14.....	14
4.	INSTALLATION.....	15
4.1	TOOLS, ACCESSORIES, TORQUES.....	15
4.2	INSTALLATION SITE REQUIREMENTS.....	15
4.3	INSTALLING THE MOB-729.....	15
4.4	METHOD OF INSTALLATION	16
4.4.1	Preparing to install	16
4.4.2	Installation.....	16
4.4.3	Opening and closing the housing.....	16
4.4.4	Grounding the optical receiver	16
5.	OPERATION.....	17
5.1	MODULE CONFIGURATION.....	17
5.1.1	Control panel.....	17

5.1.2	Local configuration and monitoring	17
5.1.3	Remote configuration and monitoring	18
5.1.4	Output module	18
5.2	CONFIGURATION OF TRANSMISSION PARAMETERS.....	20
5.2.1	Local electronic adjustment.....	20
5.2.1.1	Optical power at Input A.....	23
5.2.1.2	Optical power at Input B.....	24
5.2.1.3	Output power value – OUT	24
5.2.1.4	Interstage attenuator - ATT.....	24
5.2.1.5	Interstage equalizer - EQU.....	25
5.2.1.6	AGC.....	25
5.2.1.7	Optical input modes - OPT.....	25
5.2.1.8	IP Address.....	26
5.2.1.9	DHCP	27
5.2.1.10	MAC Adress	27
5.2.2	Remote adjustment of the MON-729/X/M via a website.....	28
5.2.2.1	Adding new users	28
5.2.2.2	Configuration tab.	29
5.2.2.3	Firmware Upload tab.....	31
5.2.2.4	Administration tab.	31
5.2.2.5	SNMP tab.	32
5.2.2.6	About tab.	33
5.3	FUNCTIONAL UNITS	34
5.3.1	Inputs and optical paths	34
5.3.2	Automatic Gain Control - AGC	34
5.3.3	Forward path amplifier	34
5.3.4	Interstage adjustment.....	34
5.3.5	Outlets.....	34
5.3.6	Test point	34
6.	STARTING WORK.....	35
6.1	INITIAL LEVEL ADJUSTMENT.....	35
7.	TECHNICAL PARAMETERS	36
7.1	OPTICAL PARAMETERS	36
7.2	FORWARD PATH.....	36
7.3	OTHER	37
7.4	MONITORED PARAMETERS (READ / WRITE).....	37
8.	SERVICE	39
8.1	INSTALLING THE C-729 LOCAL MONITORING MODULE.	39
8.2	INSTALLING OR REPLACING THE M-729 REMOTE MONITORING MODULE	40
8.3	REPLACING A FUSE IN THE POWER UNIT.....	44
9.	MARKINGS.....	47
10.	TECHNICAL SUPPORT.....	48
11.	LIST OF DRAWINGS.....	49

1. Basic information

1.1 About the manual

This manual contains information necessary for proper installation and operation of a MOB-729 optical receiver manufactured by GZT Telkom-Telmor Sp. z o.o. with its registered office in Gdańsk, ul. Mickiewicza 5/7.

GZT Telkom-Telmor reserves the right to make changes to the MOB-729 manual without prior notice.

This manual is designed for skilled and duly trained personnel responsible for installation, setup and operation of the MOB-729 optical receiver.

1.2 Copyrights

Copying, duplication and distribution of this manual, in whole or in parts, is forbidden without express written consent given by GZT Telkom-Telmor.

GZT Telkom-Telmor does not accept any responsibility for errors arising from misinterpretation of the contents of this manual. Owning or using this manual is not tantamount to holding a licence or any copyrights or patent rights. In case of any uncertainty, users of this manual may inquire GZT Telkom-Telmor Sales Department by phone or e-mail; telephone no.: +48 58 6909309, e-mail handlowy@telmor.pl

1.3 Icons

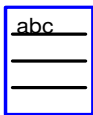

- Notes.



- WARNING! Pay special attention to any information next to this symbol.



- CAUTION, source of laser radiation. A laser beam emitted in the infrared range is invisible. If directed towards your eyes, it may cause permanent loss of eyesight.



- Warning of a risk of damage to the device by electrostatic discharge (ESD).

2. Important safety considerations

2.1 General information

The MOB-729 optical receiver manufactured by GZT Telkom-Telmor was designed and fabricated in accordance with all standards of safety, protection against harmful laser radiation, and electromagnetic compatibility.

GZT Telkom-Telmor warrants proper service of the MOB-729 if installed and operated in accordance with the conditions prescribed in this manual. GZT Telkom-Telmor does not take responsibility for any injury or property damage arising from faulty installation, modification by user, or operation not in accordance with the manual or designation of the MOB-729 optical receiver. Therefore, GZT Telkom-Telmor recommends to read this manual before commencing installation.

2.2 Checking

To avoid any problems that might occur during installation of the MOB-729, the manufacturer recommends that the customer check the device before installation. For advice in this respect, please contact GZT Telkom-Telmor Sales Department.

Retain the factory packaging until initial startup of the device.

2.3 Storage

The MOB-729 can be stored without impairment of performance in the conditions prescribed by IEC60068-2-48:

- temperature -15...+35°C,
- humidity 25...70%,
- pressure 860...1060hPa,

for 18 months of the production date.

2.4 Installation and use

The MOB-729 optical receiver is powered with electricity. For safety reasons, you should strictly obey the following rules:

- the device should be installed and replaced in accordance with local laws and regulations only by duly certified, trained and skilled maintenance personnel,
- only skilled and trained maintenance personnel should be authorized to remove any covers and access components inside the device,
- proper grounding protection may not be replaced without simultaneously attaching an extra protective grounding cable used during performance of works,
- grounding protection must necessarily be attached to the device during all repairs and servicing,
- before the device is put into service, you should verify the design and efficiency of the grounding installation.

To protect service personnel from injury and assure long-term fault-free operation of

www.telmor.pl

the device, make sure that:

- the MOB-729 is installed in an easily accessible location,
- the MOB-729 is not installed near sources of heat, such as heaters, heat lines, boilers, gas or electric cookers, etc.,
- the installation site be set near a power supply socket,
- all power cables are laid without any mechanical loads, stress, elongation, bending, etc.,
- the MOB-729 is attached to installation panel or stand in a certain and stable way,
- the installation surface or stand is anchored according to manufacturer's specifications.

2.5 Notes and warnings

2.5.1 Electrostatic discharge



During installation and maintenance works, make sure that the authorized personnel uses an grounding strip as a precautionary measure to protect the MOB-729 optical receiver from harmful electrostatic discharge (ESD).

To avoid damage from ESD, you should:

- always wear a grounded ESD wrist strap or ankle strap, in good contact with the skin,
- connect grounding strip to the MOB-729 housing,
- when moving the MOB-729, avoid touching the circuit boards or connections,
- avoid contact of circuit boards with your clothes. Antistatic wrist band protects components from electric charges gathered on your body, while electric charges on your clothes may still cause damage,
- never remove the circuit board from its enclosure.

2.5.2 Radiation



To avoid exposure to laser radiation from optical fibers, which poses hazard to your health, you should:

- never look into an exposed end of optical fiber or mirror surfaces that could reflect light from an open optical fiber;
- never watch an optical fiber connected with the radiation source with optical instruments (magnifying glass, microscope, etc.);
- use an approved fiber optic cable to maintain conformity with applicable laser safety requirements.

2.5.3 Fiber optic cables



Wearing protective goggles is recommended. You should handle fiber optic cables with extreme caution, particularly when unbundling or terminating a cable. The internal glass core of a fiber optic cable is brittle when the shielding and buffer material is removed. It will easily disintegrate into small pieces which may cause injury to the human body. Remove all filings immediately using tweezers, place them in a tightly sealed dustbin and dispose in accordance with local regulations.

2.6 Modifications

Any modifications of the optical receiver are forbidden; otherwise, your warranty may be void. Modification is only allowed to expand the functionality of the basic MOB-729/X version through installation of an M-728 remote monitoring module or a C-729 local monitoring module.

Any other modification is forbidden. It might adversely affect the level of protection integrated in the MOB-729 receiver and expose humans and property to increased risk of injury or damage. Anyone performing such modifications exposes themselves to risk of penalty for non-compliance with the laws or civil lawsuits for compensation for any injury or damage.

To replace a fuse, you should first:

- disconnect the MOB-729 from power supply,
- determine and remove the cause of blowing the original fuse.

The type and performance values of the new fuse should be identical as those of the original fuse, as specified in the MOB-729 documentation. You can find details concerning fuse replacement in the following chapter: 8.3 Replacing a fuse in the power unit.

3. General information

3.1 Introduction

The MOB-729 optical receiver described in this manual has been designed and fabricated by GZT TELKOM-TELMOR and is designated for use in HFC networks. Details of MOB-729 configuration are presented in this manual.

3.2 Features of the MOB-729

MOB-729 is a modern modular receiver dedicated to the FTTH networks, featuring one or two redundant optical inputs. The receiver has an electronic uninterruptible adjustment. A built-in AGC system maintains the RF signal at a high stable output level.

Depending on the version, the MOB-729 is controlled from a local keyboard (a hot-swap module). The monitoring module allows remote control via an RJ45 interface using the SNMPv2C standard and a built-in website. Depending on the used plugin, the receiver can support one or two "F"-type RF outputs. The built-in monitoring module also allows remote changing of output levels, setting the alarm thresholds and switching the redundant inputs, as well as monitoring the output level thanks to the integrated RF detector.

The device is powered from 230 VAC mains and available in the following versions: single-input version MOB-729/1/x, double-input version MOB-729/2/x, factory fitted with a monitoring module MOB-729/x/M or factory fitted with a local manipulator MOB-729/x/C.

High amplification of MOB-729 guarantees high output signal gain. With enabled AGC function, output signal can be maintained on a steady level within a broad range of input optical power values. Automatic gain control (AGC) is within the range of -6 to 0 dBm of input optical power. The LED display and controls on the control panel allow local control and steering of the device, thus significantly reducing the operating costs and simplifying network maintenance.

The MOB-729 can be fitted with a monitoring module for remote monitoring of specific parameters and electronic service point control. The monitoring module offers redundancy control and management, AGC, gain adjustment, slope adjustment, etc. In addition, input optical power can be monitored, internal temperature can be checked, and unauthorized opening of the housing.

Features of the MOB-729:

- dedicated to the FTTH architecture,
- uninterruptible electronic adjustment
- AGC,
- modular design,
- redundancy (MOB-729/2/X version),
- monitoring via SNMPv2c and WWW interface (MOB-729/X/M version),
- independent switching hysteresis control for each optical input with alarm threshold setting,
- measurement of the RF output signal,
- GaAs Power Doubler technology,
- local 195...253V AC / 50...60Hz power supply.

MOB-729 meets the requirements of CENELEC EN 50083 - 3 and guarantees electromagnetic compatibility in accordance with IEC 60728-2.

3.3 Block diagram

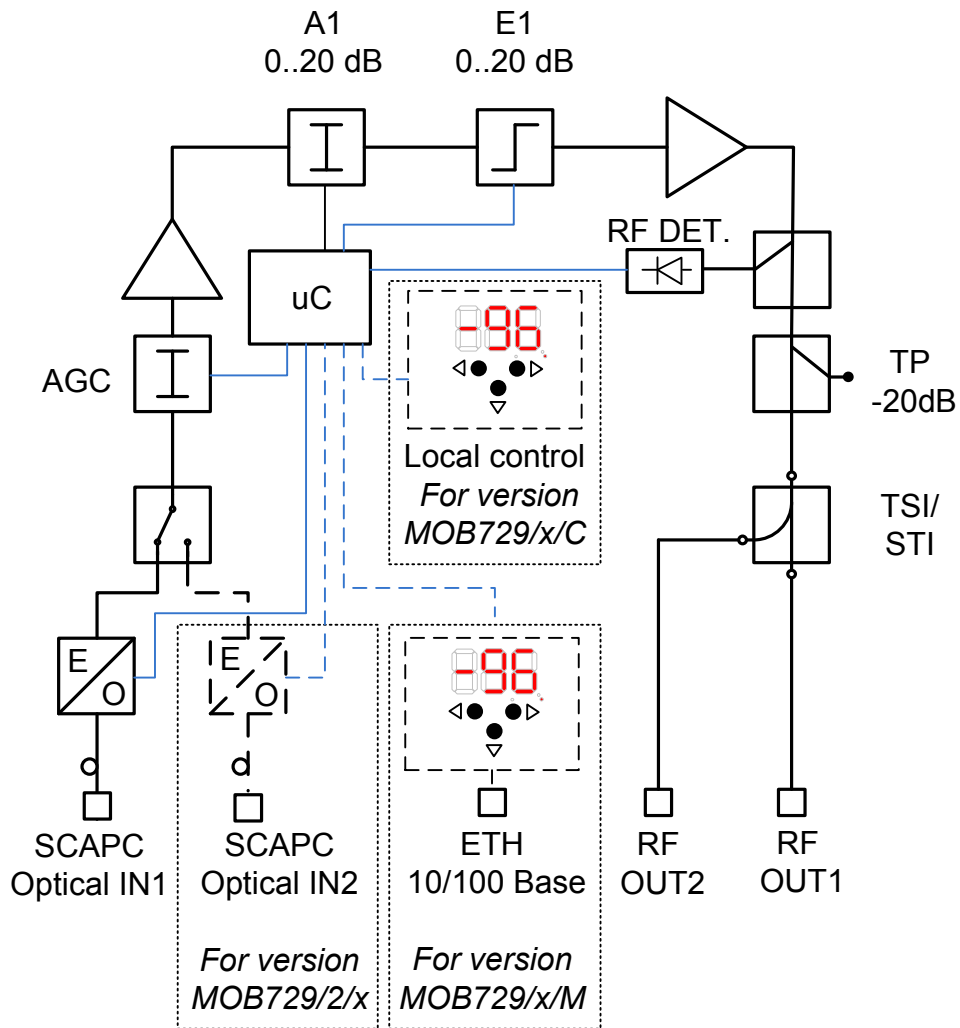

Fig. 3.1. Block diagram of the MOB-729 optical receiver.

3.4 Functional units

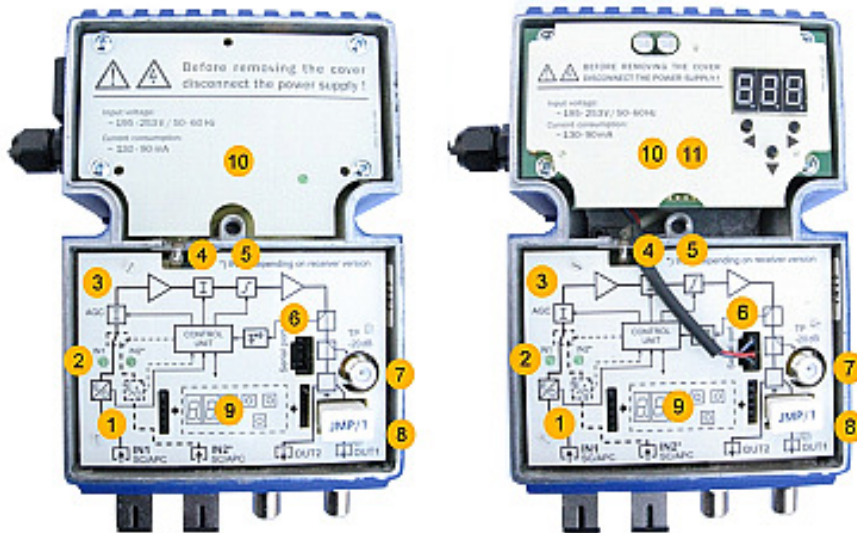
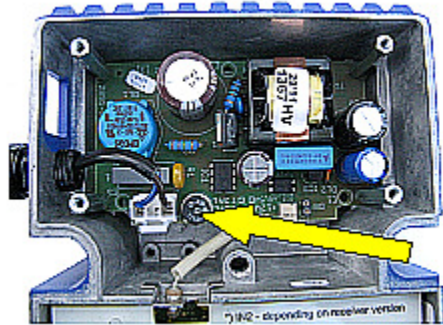

Fig. 3.2. MOB-729/2 optical receiver. Fig. 3.3. MOB-729/2/M optical receiver.

1. Optical paths
 - Chapter 5.2.1.1 Optical power at Input A
 - Chapter 5.2.1.2 Optical power at Input B (MOB-729/2/X)
 - Chapter 5.2.1.7 Operating modes of optical inputs
 - Chapter 5.3.1 Inputs and optical paths
2. Optical path status - LED indication
 - Chapter 5.3.1 Inputs and optical paths
3. Built-in AGC
 - Chapter 5.2.1.6 AGC
 - Chapter 5.3.2 Automatic Gain Control - AGC
4. Built-in attenuator
 - Chapter 5.2.1.4 Interstage attenuator - ATT
 - Chapter 5.3.4 Interstage equalization
5. Built-in equalizer
 - Chapter 5.2.1.5 Interstage equalizer - EQU
 - Chapter 5.3.4 Interstage equalization
6. Serial port
 - Chapter 8.2 Installing or replacing the M-729 remote monitoring module
7. Tracking point
 - Chapter 5.3.6 Tracking point
8. OUT1 and OUT2 output configuration module
 - Chapter 3.6.3 JMP/1 – jumper module
 - Chapter 3.6.4 STI-3,5
 - Chapter 3.6.5 TSI 2/6, TSI 1/9, TSI 1/12, TSI 1/14
 - Chapter 5.1.2 Output module
9. C-729 local monitoring module
 - Chapter 3.6.1 C-729 local monitoring module
 - Chapter 5.1.1.1 Local configuration and monitoring
 - Chapter 5.2.1 Local electronic adjustment
 - Chapter 8.1.1 Installing the C-729 local monitoring module

- 10. Power unit
 - Chapter 3.5 Power unit
 - Chapter 8.3 Replacing a fuse
- 11. M-729 remote monitoring module
 - Chapter 3.6.2 M-729 remote monitoring module
 - Chapter 5.1.1.2 Remote configuration and monitoring
 - Chapter 5.2.1 Local electronic adjustment
 - Chapter 8.2 Installing or replacing the M-729 remote monitoring module

3.5 Power unit



Fuse location.

Fig. 3.4. Power unit view.

3.5.1 Fuse



Check correct grounding before connecting to power supply! An electric shock can be a hazard to your life or health.



When replacing a fuse in the power unit, make sure that the device is disconnected from the power unit. For more information, see chapter 8.3 Replacing a fuse in the power unit.

The MOB-729 optical receiver is powered from local 195...253V AC / 50...60Hz mains. The device is factory fitted with two-core network cable terminated with a plug.

3.6 Plug-in modules

With the design of the optical receiver, outputs can be configured depending on the required degree of splitting and output level, with the option of using plug-in C-729 and M-729 modules for local and remote electronic adjustment and monitoring purposes.

3.6.1 C-729 local monitoring module

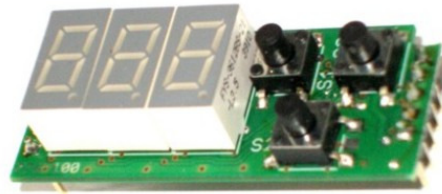
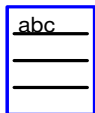

Fig. 3.5. C-729 local monitoring module.

The C-729 is a local monitoring module for the MOB-729 receiver. If monitoring is not necessary, the receiver can be fully controlled via a three-digit display and a three-button keyboard. The C-729 module can be installed or removed during the receiver operation; thus, multiple MOB-729 optical receivers can be set via a single module.



Installation of this module - see chapter 8.1 Installing the C-729 local monitoring module.

3.6.2 M-729 remote monitoring module



Fig. 3.6. M-729 remote monitoring module.

M-729 is a monitoring module for local management and control of a MOB-729 optical receiver. With the microprocessor technology implemented in the receiver, the user can fully control the optical parameters as well as RF. With the installed detector, the user can remotely measure the RF output level and remotely set the switching hysteresis for the double-input version. Apart from controls, alarms can also be set, sending alarm traps to the specified IP address through SNMPv2c communication protocol. With SNMP standard, WWW interface is also available. The monitoring module is fitted with a three-digit display and keyboard for local changing of parameters. The M-729 module has a unique MAC address and an integrated automatic IP address acquisition from DHCP server function.

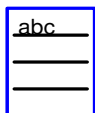

Installation of this module - see chapter 8.2 Installing or replacing the M-729 remote monitoring module.

3.6.3 JMP/1 – jumper module

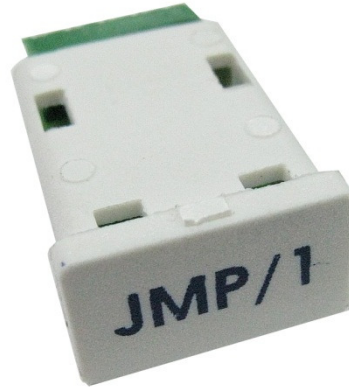

Fig. 3.7. JMP/1 – jumper module.

With the use of JMP/1 jumper module, high frequency signal is transmitted directly to OUT1. OUT2 is not connected to the high frequency path.

3.6.4 STI-3,5



Fig. 3.8. STI-3,5 module.

The STI-3,5 is designed for uniform splitting of high frequency signal between two ports: the OUT1 and OUT2.

Type	Attenuation between module input and OUT1	Attenuation between module input and OUT2
STI-3,5	3.7 dB	3.7 dB

3.6.5 TSI 2/6, TSI 1/9, TSI 1/12, TSI 1/14



Fig. 3.9. TSI module – 2/6.

TSI line modules are designed for splitting high frequency signal between two ports: the OUT1 and OUT2 in appropriate proportions. The table below presents types of TSI line modules and corresponding attenuation values at OUT1 and OUT2.

Type	Attenuation between module input and OUT1	Attenuation between module input and OUT2
TSI 2/6	2 dB	6 dB
TSI 1/9	1 dB	9 dB
TSI 1/12	1 dB	12 dB
TSI 1/14	1 dB	14 dB

4. Installation

4.1 Tools, accessories, torques

Before commencing installation, make sure that you have the following tools and equipment for connecting and configuration of the MOB-729 optical receiver.

You need...	to...
A Phillips screwdriver PH3	remove and attach cover.
A Phillips screwdriver PH1	to remove/attach the power unit enclosure or the M-729 monitoring module.
A wrench or screwdriver appropriate for the selected affixing screws.	attachment to base.

4.2 Installation site requirements

A housing protects the electrical device from environmental impacts and overheating. The aluminum housing with very good heat removal qualities guarantees optical receiver operation within a broad range of temperature (-20 ÷ +55°C). The MOB-729 is protected to IP24. A rubber ring in the cover prevents penetration of moisture to the inside of the device.

4.3 Installing the MOB-729

The compact optical receiver housing requires little installation space. The receiver can be installed in free-standing cabinets and in indoor enclosures. Shape of the receiver body ensures its easy installation directly to base. The MOB-729 is fitted with two high frequency outputs and one or two SC/APC optical inputs, depending on the model, located at the bottom of the housing. An extra cable gland is fitted on the left side of the housing, through which a cable is connected, terminated with a socket to local power supply system. Cover of the optical receiver is attached to the body with a single screw.



Fig. 4.1. View on the housing of the MOB-729 optical receiver.

4.4 Method of installation

4.4.1 Preparing to install

Before installing the MOB-729 optical receiver, you should visually inspect the housing carefully, paying special attention to any defects to optical inputs and "F" outputs.

4.4.2 Installation

Attach the optical receiver to base with two screws, diameters not exceeding \varnothing 5 mm, head diameter not exceeding \varnothing 9 mm.



The optical receiver should be installed in vertical position so that signal cables run downwards. Otherwise, proper air circulation can be disrupted and the receiver may overheat.

4.4.3 Opening and closing the housing

To open/close the MOB-729 optical receiver, remove/attach one central cover fixing screw. Use the PH3 Phillips screwdriver for this purpose.

4.4.4 Grounding the optical receiver

The MOB-729 must be grounded for safe operation. A screw for attaching a grounding wire is located on the right side of the optical receiver. The MOB-729 should be grounded with a 4mm² section copper wire.



Check correct grounding before switching on power supply! An electric shock can be a hazard to your life or health.

www.telmor.pl

5. Operation

Setting and monitoring of the MOB-729/X/X can be done, depending on version, via:

- C-729 local monitoring module,
- M-729 remote monitoring module.

5.1 Module configuration

5.1.1 Control panel

The MOB-729 optical receiver is fitted with an integrated microprocessor that controls the settings and monitors the device operation. The MOB-729 can be configured locally or remotely, depending on the optical receiver options.

5.1.2 Local configuration and monitoring

The MOB-729/X/C versions are fitted with a C-729 local monitoring module, enabling the user to configure the device with function keys and numerical LED indication inside the device, on the C-729 module.

The local monitoring module can be removed and placed into the optical receiver during normal service, without fear of damage. With this solutions, a single C-729 local monitoring module can handle multiple optical receivers. Information about the C-729 local monitoring module can be found in the following chapters:

- 3.6.1 C-729 local monitoring module,
- 8.1 Installing the C-729 local monitoring module.



Fig. 5.1. Interior of the MOB-729 optical receiver with a C-729 local monitoring module.

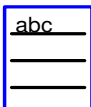

Information about installation of the C-729 module - see chapter 8.1 Installing the C-729 local monitoring module.

5.1.3 Remote configuration and monitoring

The MOB-729/X/M versions are factory fitted with an M-729 remote monitoring module enabling the user to manage the device remotely via a website.

Irrespective of the remote optical receiver management options, the MOB-729/X/M versions also feature local device configuration with function keys and numerical LED indication inside the device, on the M-729 module.



Fig. 5.2. Interior of the MOB-729 optical receiver with a factory fitted M-729 remote monitoring module.

The user may expand the basic MOB-9279/X version to MOB-729/X/M through installing an extra purchased M-729 remote monitoring module manufactured by GZT Telkom - Telmor.

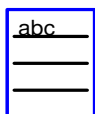

Information about installation of the M-729 module - see chapter 8.2 Installing or replacing the M-729 remote monitoring module.

5.1.4 Output module

In order to close the signal path, one of three output modules need to be installed in the appropriate port (see the figure below). Depending on the required output configuration, you should install the following:

- JMP/1 (see chapter 3.5.3 JMP/1) or
- STI-3,5 (see chapter 3.5.4 STI-3,5) or
- TSI X/X (see chapter 3.5.5 TSI 2/6, TSI 1/9, TSI 1/12, TSI 1/14).

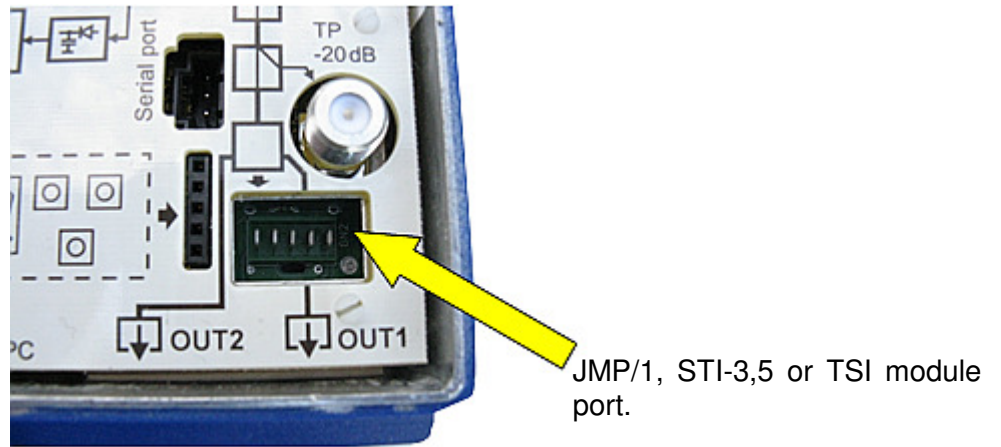

Fig. 5.3. JMP/1, STI-3,5 or TSI module port in the MOB-729 optical receiver.



Make sure that 75 Ω terminators are affixed to unused outputs.

5.2 Configuration of transmission parameters

5.2.1 Local electronic adjustment

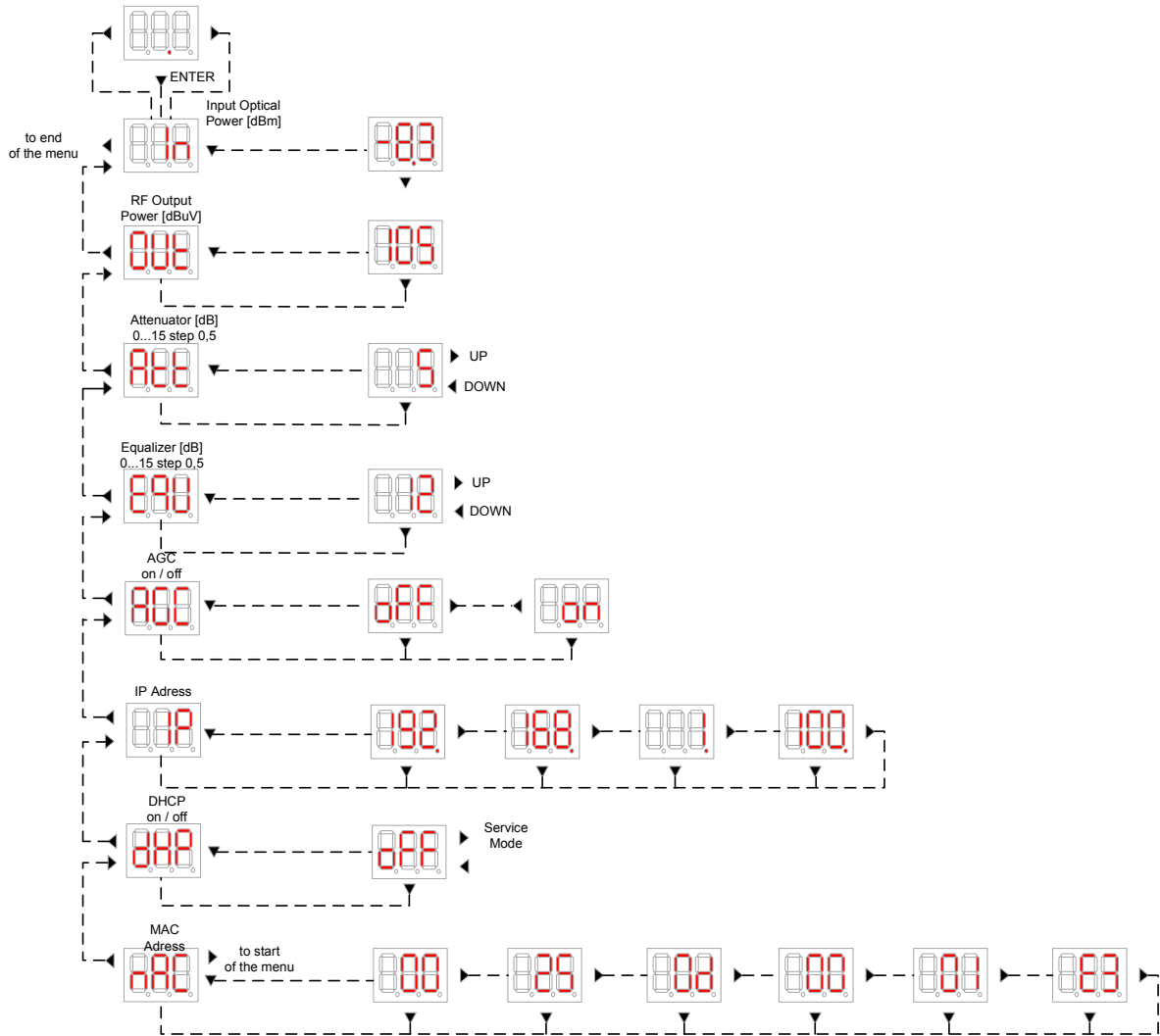

Fig. 5.4. Local electronic adjustment of the MOB-729/1/M – menu tree.

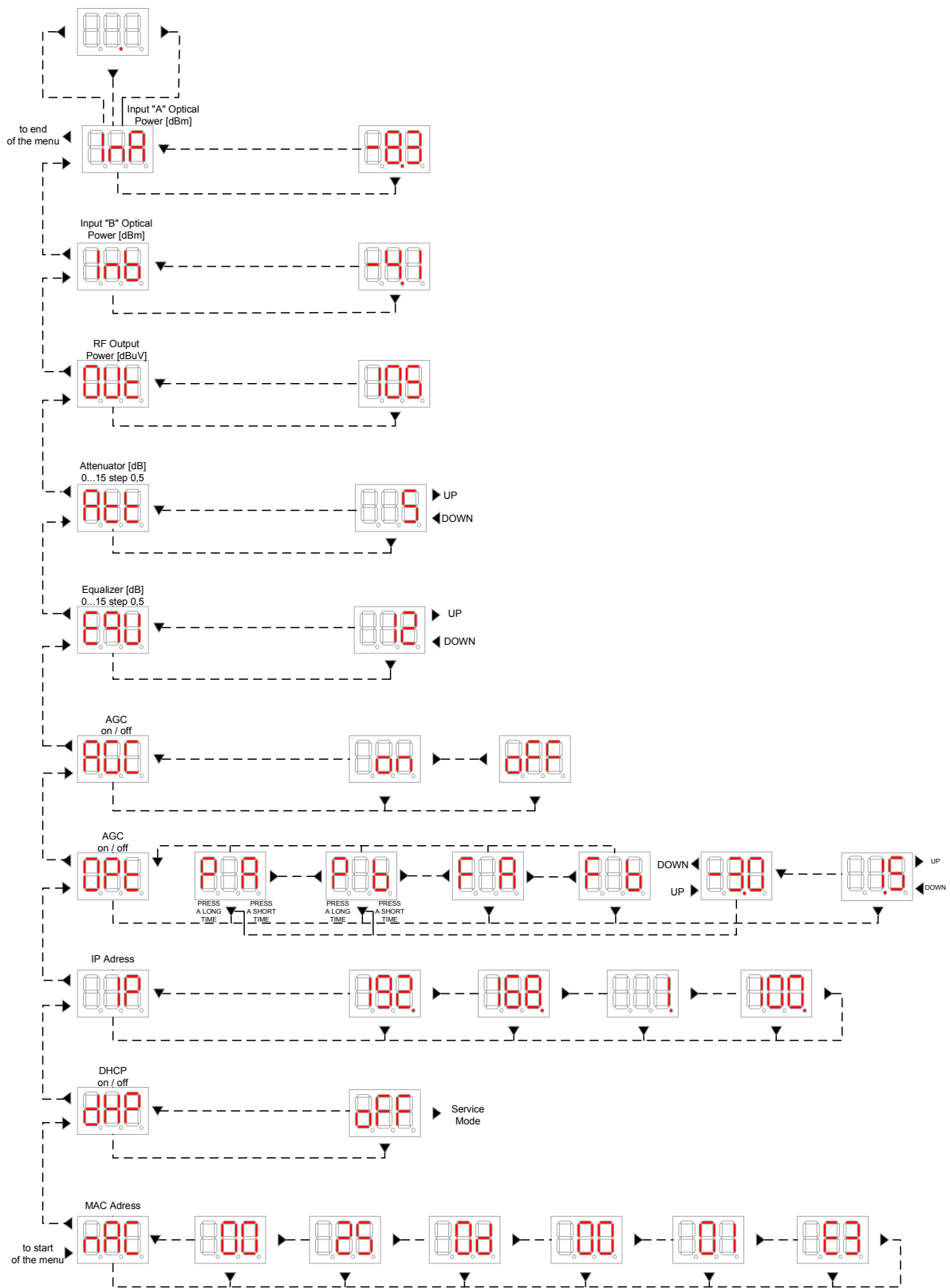

Fig. 5.5. Local electronic adjustment of the MOB-729/2/M – menu tree 2.

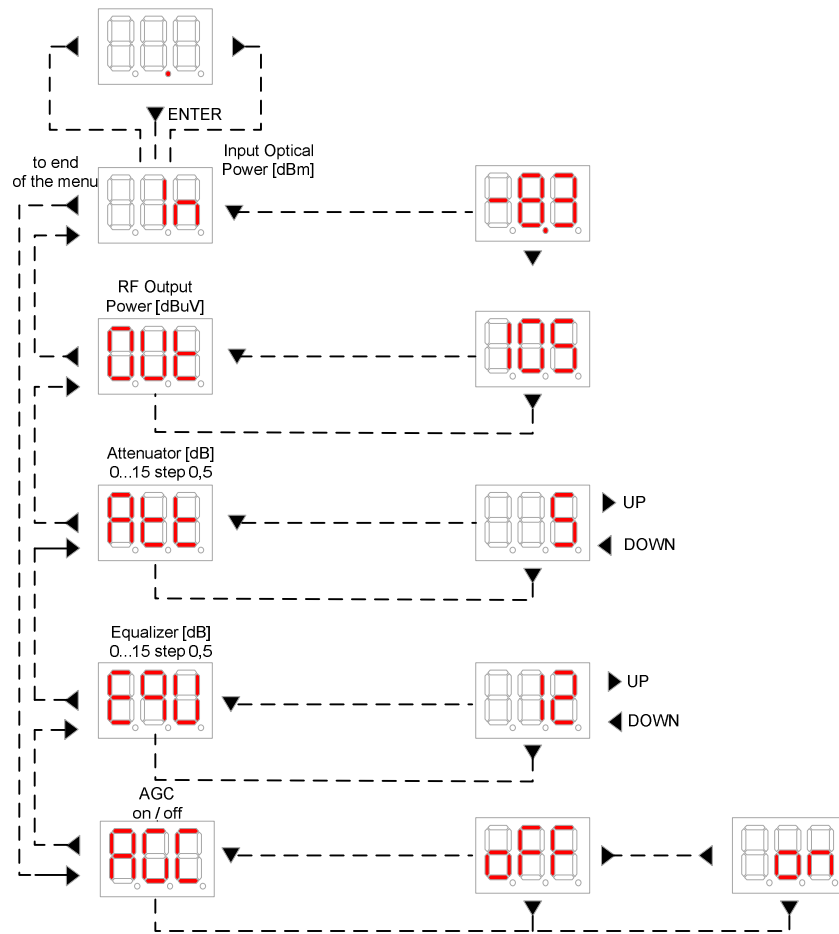

Fig. 5.6. Local electronic adjustment of the MOB-729/1/C – menu tree.

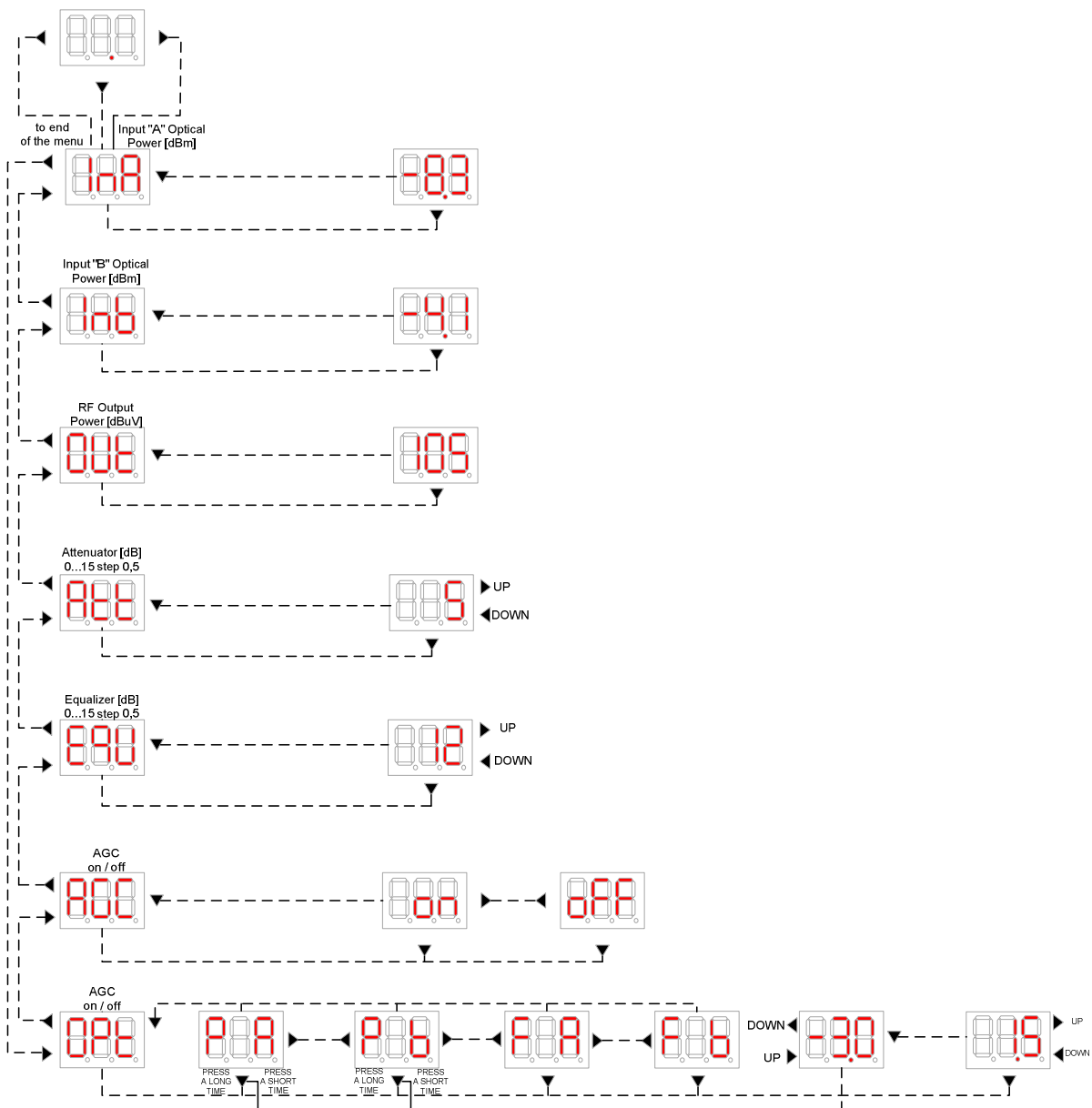

Fig. 5.7. Local electronic adjustment of the MOB-729/2/C – menu tree.

In the main menu, using the menu buttons marked with appropriate icons, you can choose from a number of functions described below to read the parameters and make correct configuration settings of the MOB-729.

5.2.1.1 Optical power at Input A

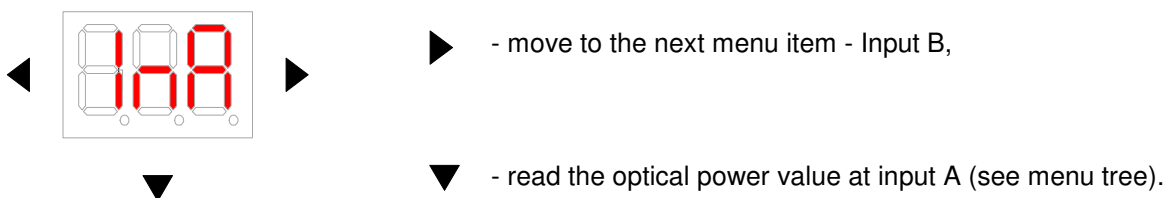

Fig. 5.6. LED indication of the MOB-729 optical receiver.

Input optical power is measured within the range from -9.9 to $+2.9$ dBm and displayed

with the accuracy to 0.1 dBm. **Lo** (low) symbol is displayed below the value of -9.9 dBm. If you briefly ▼ press the button again, you will return to the main menu.

5.2.1.2 Optical power at Input B

Input B is present only in the double-input version - MOB-729/2/x.

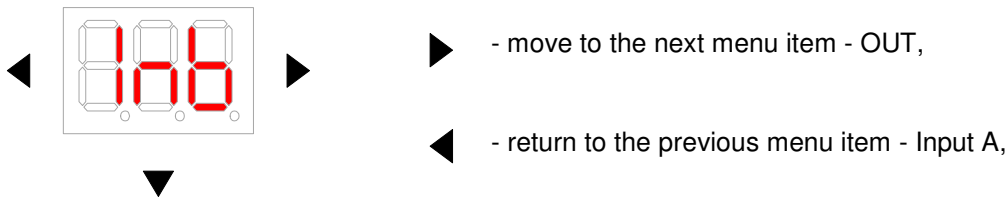

Fig. 5.7 LED indication of the MOB-729 optical receiver.

Input optical power is measured within the range from -9.9 to +2.9 dBm and displayed with the accuracy to 0.1 dBm. **Lo** (low) symbol is displayed below the value of -9.9 dBm.

If you briefly press the ▼ button again, you will return to the main menu.

5.2.1.3 Output power value – OUT

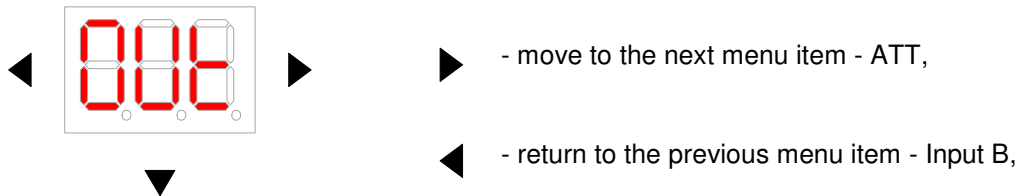

Fig. 5.8. LED indication of the MOB-729 optical receiver.

Output level is measured within the range from 91 to 119 dBuV and displayed with the accuracy to 1 dBuV. Signal measurement is scaled to 42 CH CELENEC. **Lo** (low) symbol is displayed below the value of 90 dBuV. If you briefly press the ▼ button again, you will return to the main menu.

5.2.1.4 Interstage attenuator - ATT

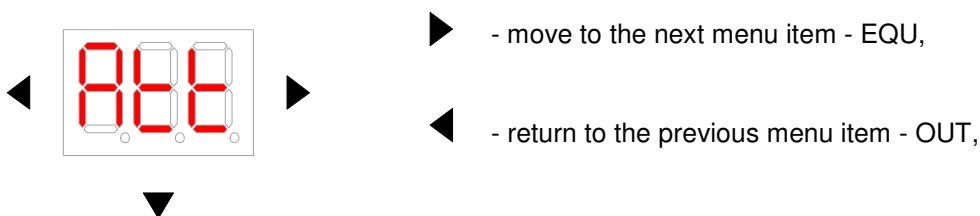

Fig. 5.9. LED indication of the MOB-729 optical receiver.

Interstage attenuator settings can be changed through pressing the ◀ ▶ buttons. The value of the interstage attenuator is set within the range of 0...15 dB with a step at 1 dB. If you briefly press the button again, the settings will be accepted and you will return to

the main menu.

5.2.1.5 Interstage equalizer - EQU

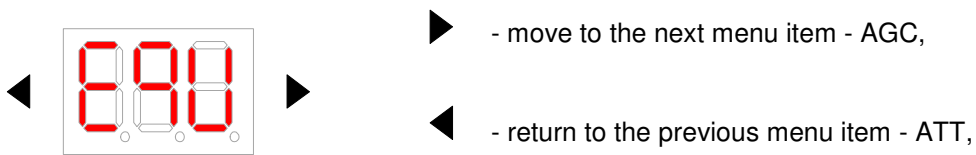

Fig. 5.10. LED indication of the MOB-729 optical receiver.

- ▶ - move to the next menu item - AGC,
- ◀ - return to the previous menu item - ATT,
- ▼ - move to reading the values and settings of the EQU - interstage equalizer (see menu tree).

Interstage equalizer settings can be changed through pressing the ◀ ▶ buttons. The value of the interstage equalizer is set within the range of 0...15 dB with a step at 1 dB. If you briefly press the ▼ button again, the settings will be accepted and you will return to the main menu.

5.2.1.6 AGC

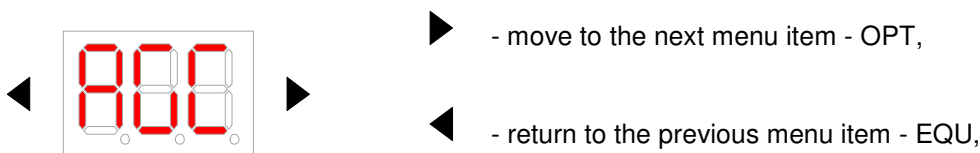

Fig. 5.11. LED indication of the MOB-729 optical receiver.

- ▶ - move to the next menu item - OPT,
- ◀ - return to the previous menu item - EQU,
- ▼ - move to reading the settings and modifications of the AGC (on/off) (see menu tree).

Use the ◀ ▶ buttons to change the Automatic Gain Control (AGC) settings. You can choose from two AGC modes:

- **off** - AGC off – input circuits of the optical receiver do not attenuate and output level increases in proportion to the increase of input optical power.
- **on** – AGC on – input circuits of the optical receiver generate variable attenuation during changes of optical input power. The purpose of automatic gain control is to ensure a fixed output level within a broad range of input level changes. AGC is recommended when optical input power is within the range from -6 dBm to 0 dBm.

If you briefly press ▼ the button again, the settings will be accepted and you will return to the main menu.

5.2.1.7 Optical input modes - OPT

OPT is present only in the double-input version of the MOB-729.



Fig. 5.12. LED indication of the MOB-729 optical receiver.

- ▶ - move to the next menu item - IP,
- ◀ - return to the previous menu item - AGC,
- ▼ - move to reading the settings and modifications of optical input preferences (see menu tree).

Use the ◀ ▶ buttons to set the mode for optical inputs. You can choose from four settings:

- **FA** – forced A mode – only optical input A is enabled, input B is disabled.
- **FB** – forced B mode – only optical input B is enabled, input A is disabled.
- **PA** – A redundancy mode – optical input A is set as primary when input signal power is within the preset power range for the redundancy key.

To switch to power range setting for the redundancy key (in PA mode), press and hold the ▼ button - see menu tree. Use the ◀ ▶ buttons to set the lower limit of the range. When you have finished setting the lower limit, press the ▼ button briefly to switch to setting the upper limit of the redundancy key range. Use the ◀ ▶ buttons to set the upper limit of the range. Press the button again briefly to return to the main menu.

When optical power at input A changes and exceeds the preset range, the CPU will verify the optical power of signal at input B. If the value of optical power at input B is within the preset range, then the inputs will be switched and signal will come from input B. However, if signal power at both inputs is outside the preset range, the CPU will compare optical power values at both inputs and switch on the input with higher optical power level.

- **PB** – B redundancy mode – optical input B is set as primary when input signal power is within the preset range for the redundancy key.

To switch to power range setting for the redundancy key (in PB mode), press and hold the ▼ button - see menu tree. Use the ◀ ▶ buttons to set the lower limit of the range. When you have finished setting the lower limit, press the ▼ button briefly to switch to setting the upper limit of the redundancy key range. Use the ◀ ▶ buttons to set the upper limit of the range. Press the ▼ button again briefly to return to the main menu.

When optical power at input B changes and exceeds the preset range, the CPU will verify the optical power of signal at input A. If the value of optical power at input A is within the preset range, then the inputs will be switched and signal will come from input A. However, if signal power at both inputs is outside the preset range, the CPU will compare optical power values at both inputs and switch on the input with higher optical power level.

5.2.1.8 IP Address

IP address is only available for the MOB-729 version fitted with an M-729 remote monitoring module.

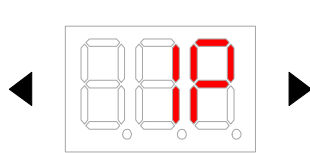

Fig. 5.13. LED indication of the MOB-729 optical receiver.

- ▶ - move to the next menu item - DHCP,
- ◀ - return to the previous menu item - OPT,
- ▼ - move to reading the values of IP address (see menu tree).

To see the subsequent parts of the IP address, press the ▶ button briefly three times. When you briefly press the button for the ▶ fourth time, you will return to the main menu.

5.2.1.9 DHCP

DHCP is only available for the MOB-729 version fitted with an M-729 remote monitoring module.



Fig. 5.14. LED indication of the MOB-729 optical receiver.

- ▶ - move to the next menu item - MAC Address,
- ◀ - return to the previous menu item - IP,
- ▼ - move to reading the settings and modifications of DHCP (see menu tree).

To change the DHCP settings, use the◀▶ buttons. You can choose from two DHCP settings:

- **off** - DHCP off – static IP enabled. Static IP address can be set via website interface or SNMP,
- **on** - DHCP on – IP acquired from server.

When you press the ▼ button again, the settings will be accepted and main menu will be restored.

5.2.1.10 MAC Address

MAC Address is only available for the MOB-729 version fitted with an M-729 remote monitoring module.

To display the next hex pair of address, press the ▼ button again.

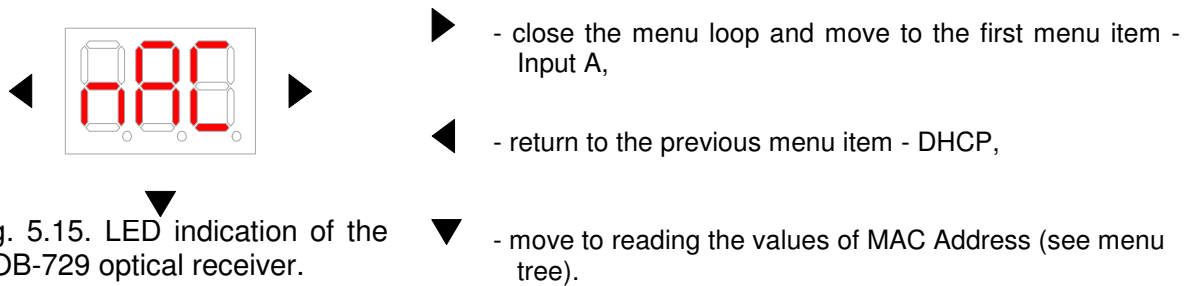

Fig. 5.15. LED indication of the MOB-729 optical receiver.

5.2.2 Remote adjustment of the MON-729/X/M via a website

Four accounts are defined in your new device: administrator account with log-in name and password: "admin", and four user accounts with log-in names and passwords: "userX", X – user no. The maximum acceptable number of users is three.

After you log on to the MOB-729/X/M using the log-in name and password set by the administrator in charge of the device or the standard log-in names and passwords, you will see the MOB-729/X/M welcome page as presented on fig. 5.16.

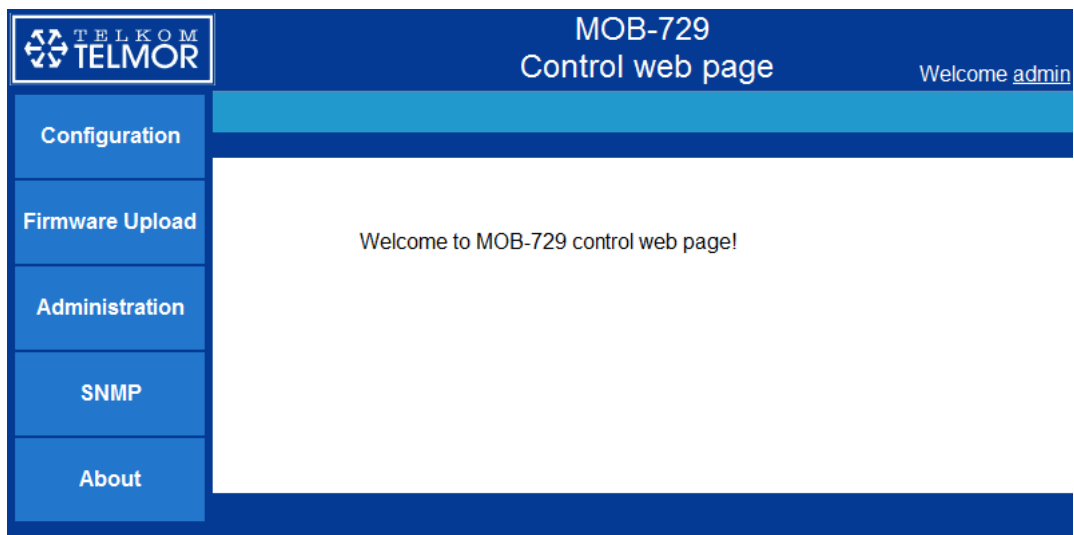

Fig. 5.16. Web interface - welcome page.

5.2.2.1 Adding new users

To change user attributes, click the "admin" tab in the right upper corner of the welcome page of the www interface. When you do this, a dialog will display as presented on fig. 5.17. To define a new user, you only have to fill in the table presented on the figure below. Assign a log-in name and password to the new user and press "Apply".

Only the administrator is authorized to add new users or to change log-in names and passwords for all existing users. A user without administrator privileges may only change the log-in name and password to his profile, provided however that this user has been assigned such privileges by the administrator. To learn more about user privileges, see section "Administration tab".

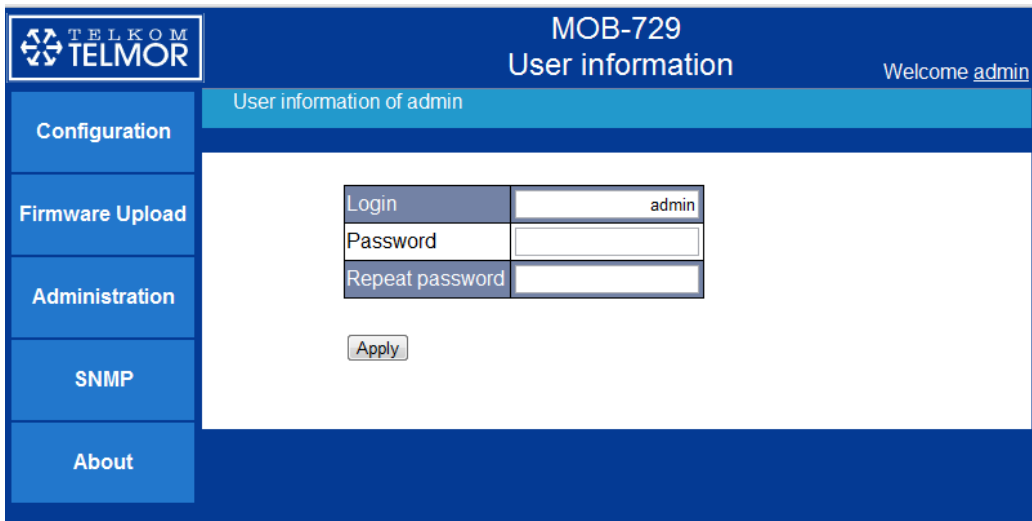

Fig. 5.17. Defining users.

5.2.2.2 Configuration tab.

If you choose the Configuration tab, a window will be displayed as see on fig. 5.18. It is the block diagram of the MOB-729/X/M with editable fields highlighted.

The user can change parameter values within the range from 0 to 15 dB for the attenuator and equalizer with 1 dB step. In addition, you can enable or disable automatic gain control. You can force the MOB-729/X/M optical inputs mode through choosing the desired mode from the list. To learn more, see chapter 5.2.1.7 "Optical inputs mode".

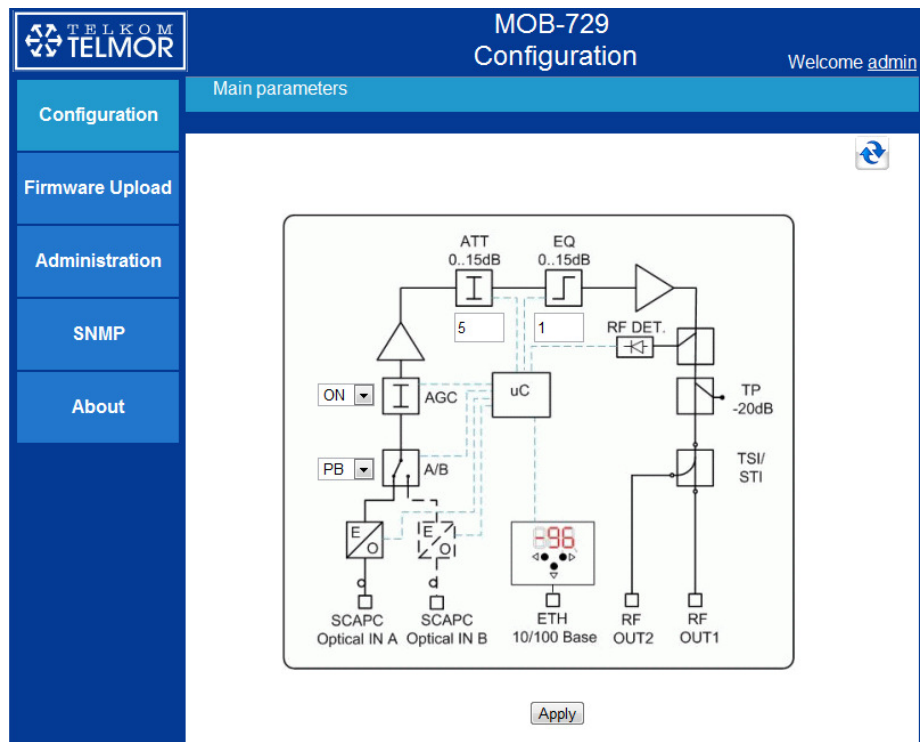

Fig. 5.18. Configuration tab.

If the maximum value of the parameter defined on screen is exceeded, the user will see

a relevant message (fig. 5.19):

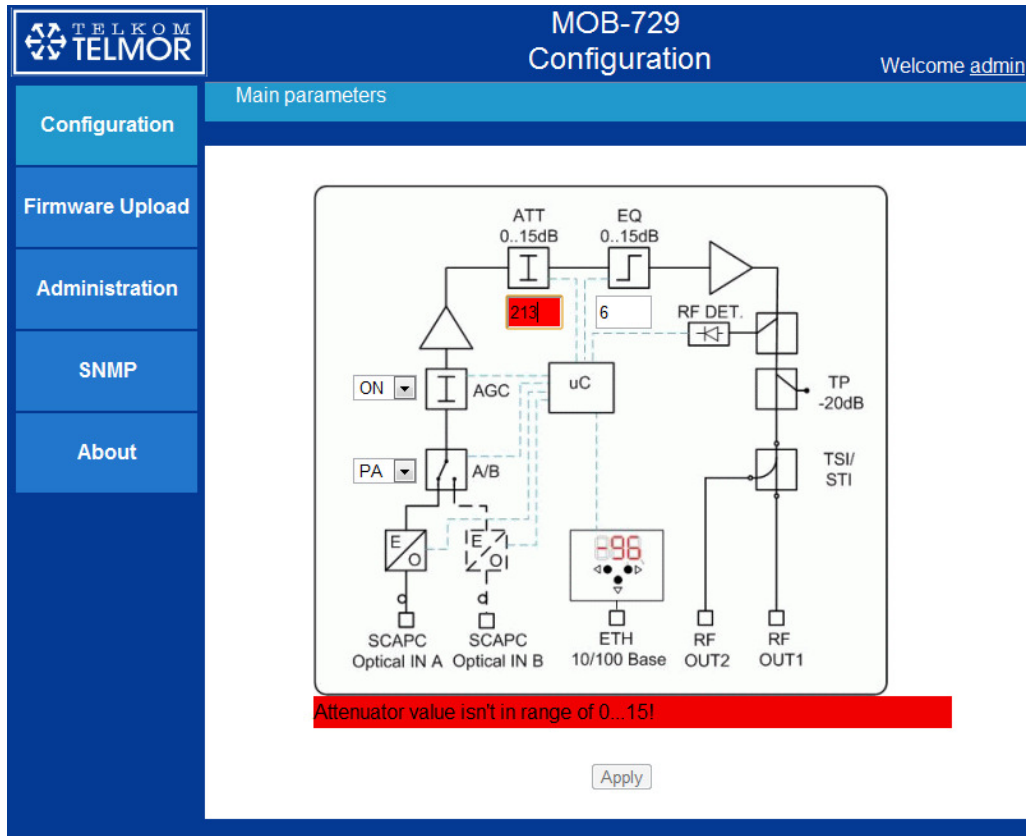

Fig. 5.19. Maximum setpoint exceeded.

Fig. 5.20 presents a list of other parameters.

Other parameters:

- **Optical Receiver Power Channel A/Optical Receiver Power Channel B** – two values are available. Low indicates no optical signal, High means a signal beyond acceptable level.
- **Optical Receiver AB Switch State** – this parameter indicates the optical output from which signal is processed at the moment,
- **Automatic Optical Gate Switching Lower Limit/Automatic Optical Gate Switching Upper Limit** – this is a user-adjustable parameter. Its function is to maintain the desired input signal level. If the signal level exceeds one of the preset values, transmission channels will be switched automatically.
- **Temperature** – this parameter shows the current temperature inside the device,
- **Housing** – this parameter shows the housing open/closed status.

Other parameters	
Optical Receiver Power Channel A	Low
Optical Receiver Power Channel B	Low
Optical Receiver AB Switch State	IN B
RF Port Output Level	Low
Automatic Optical Gate Switching Lower Limit	-4 dBm
Automatic Optical Gate Switching Upper Limit	0 dBm
Temperature	33
Housing	CLOSED

Fig. 5.20. Configuration tab.

If you press "Set default settings", all parameters will be set to default values for the device; this applies to all values.

5.2.2.3 Firmware Upload tab.

With the Firmware Upload tab, you can easily update the monitoring module software version. As shows in fig. 5.21, the user should select the desired software file and click "Apply" to send his choice to the CPU. If the update process is interrupted, the device will operate on the basis of the previous software version.

Please choose a hex file with new firmware for the device.

Choose file for upload:

Nie wybrano pliku

Fig. 5.21. Firmware Upload tab

5.2.2.4 Administration tab.

In this tab, you can configure two types of parameters. First - the network parameters of the device, second - privileges attributable to predefined users.

If you enable dynamic IP address retrieval, the option of manual IP address allocation is automatically disabled. Only if "DHCP Enable" is unchecked, you will be able to allocate IP address, subnet mask and gate manually. The parameter table also shows the network card MAC address.

A predefined list of users is displayed under the network parameters table. In the Administration tab, system administrator may allocate privileges to every user. As shown in fig. 5.22, each user can be allocated only read privileges or read and write privileges to MOB-729/X/M parameters. In addition, every user can have the option of changing the log-in name and password to his profile.

The screenshot shows the MOB-729 Administration interface. The top bar includes the TELKOM TELMOR logo, the title 'MOB-729 Administration', and a 'Welcome admin' message. A left sidebar contains navigation tabs: Configuration, Firmware Upload, Administration (selected), SNMP, and About. The main content area is titled 'Administration options' and contains a DHCP configuration table.

DHCP	<input checked="" type="checkbox"/> DHCP Enable
IP Address	192 . 168 . 6 . 197
Subnet Mask	255 . 255 . 255 . 0
Default gateway:	192 . 168 . 6 . 1
MAC address:	00:25:0D:00:00:08

Below the table is an 'Apply' button. The interface then shows a user configuration section for 'user1' with the following options:

- Read
- Read/Write
- Reset login and password for that user

An 'Apply' button is located at the bottom of this section.

Fig. 5.22. Administration tab.

5.2.2.5 SNMP tab.

MOB-729/X/M allows monitoring and configuration of parameters through SNMP (Simple Network Management Protocol) protocol. To exercise this option, you must correctly assign the "SNMP Agent Properties" and "Alarms" attributes.

Access configuration for SNMP agent only involves filling in the table presented on fig. 5.23. Enter the address of the agent in which it operates, define the port where it will be receiving, and enter the passwords to enable communication. If you fill in the table and press "Apply", you will be able to connect to the device via an SNMP client.

In the tab below, you can also define threshold values of parameters which, if exceeded, will be automatically communicated by the MOB-729/X/M through sending TRAP messages to the SNMP agent. These parameters include:

- service temperature of the device,
- signal level at device input,
- signal level at device output.

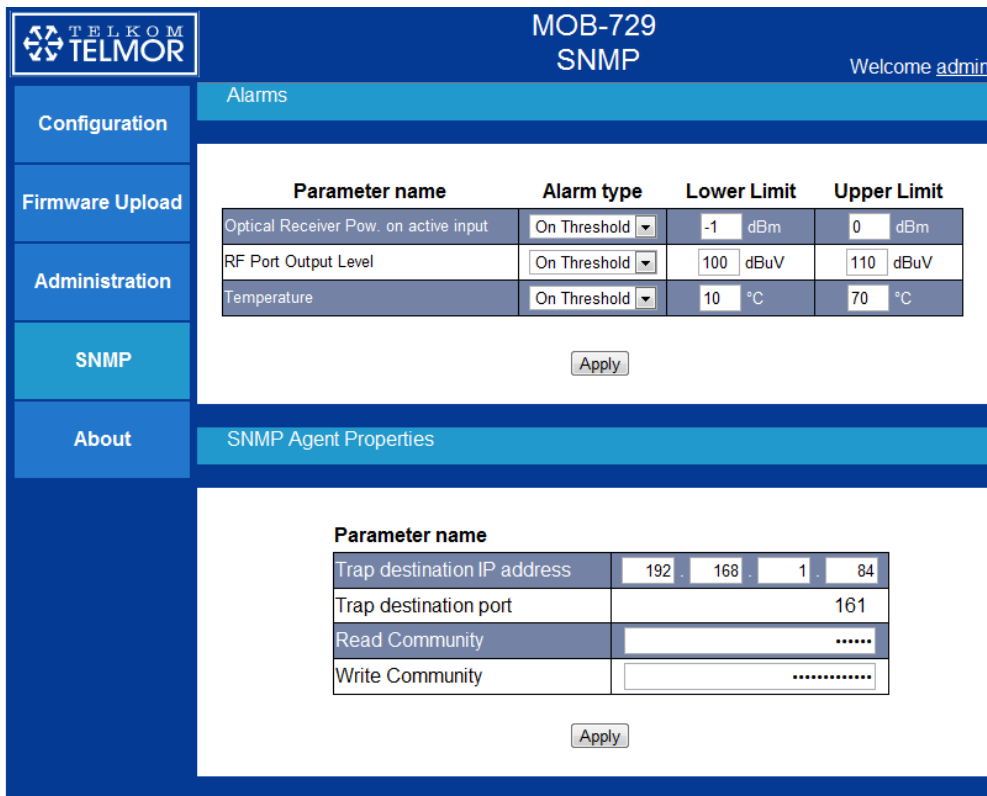

Fig. 5.23. SNMP tab.

To prepare SNMP agent you'll need MIB's. To have more information ask your sales representative.

5.2.2.6 About tab.

The "About" tab displays information concerning the current version of firmware installed in the MOB-729/X/M and the device location entered by the administrator. To edit the current location of the MOB-729/X/M, enter a description in the table and press "Apply". The table layout is presented on fig. 5.24.

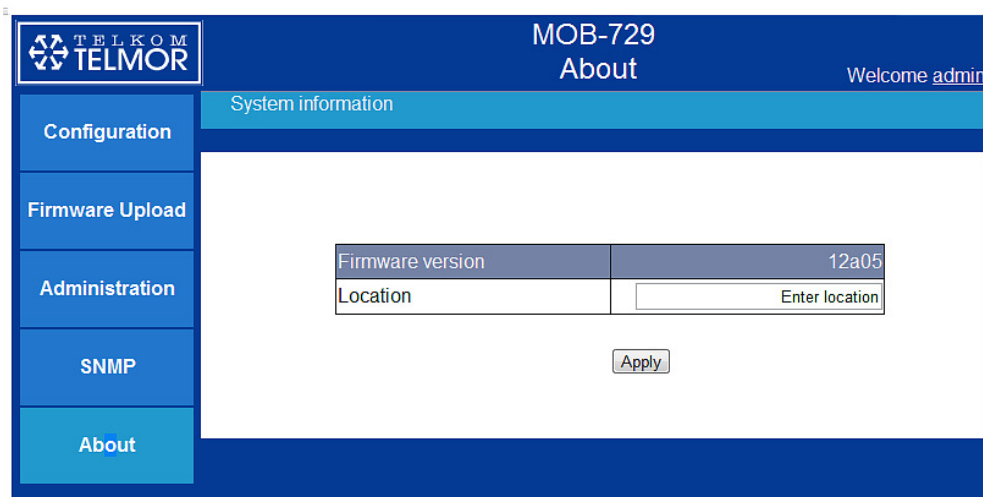

Fig. 5.24. About tab.

5.3 Functional units

5.3.1 Inputs and optical paths



Input optical power supplied to the optical inputs should not exceed +1dBm. Exceeding +3dBm optical power at the optical inputs poses a risk of irreparable damage to the receiver!

The optical receiver may be fitted with one or two SC/APC optical inputs, depending on version. Two green LEDs in the RF section enclosure of the MON-729 receiver are used to indicate the currently enabled inputs to the user.

Optical paths may operate in one of four modes - two forced modes or two preference modes for redundant operation. Detailed descriptions of optical path modes and switching instructions are presented in chapter 5.2.1.7 Operating modes of optical inputs

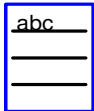

To optimize the efficiency of your optical receiver, it should operate within the range of -6...0dBm of optical power input.

5.3.2 Automatic Gain Control - AGC

An enabled AGC circuit allows automatic gain adjustment. CPU tracks the input optical power and changes the optical receiver gain according to the power value, maintaining a steady power level at output. AGC works in a 6 dBm window, guaranteeing maximum range of high frequency attenuator of 12dB.

5.3.3 Forward path amplifier

Implementation of state-of-the-art technology and microprocessor control guarantees full optimization, high level of high frequency at optical receiver output and low level of intermodulation distortion.

5.3.4 Interstage adjustment

Interstage adjustment is provided through an electronic interstage attenuator - ATT, set in the range of 0 to 15 dB, step 1 dB, and an electronic equalizer - EQU, set in the range of 0 to 15 dB, step 1 dB. Forward patch gain and characteristic slope is verified electronically, through a control panel.

Slope value is determined between markers at 47 MHz and 862 MHz.

5.3.5 Outlets

The MOB-729 is fitted with two "F" signal outputs. Output signal is configured by user through one of the selected modules: the JMP/1 jumper, the STI splitter or a TSI (time-slot interchange).

5.3.6 Test point

A directional TP tracking point with an "F" connector, attenuation -20 dB.

6. Starting work

6.1 Initial level adjustment

Forward path of the MOB-729 optical receiver can be adjusted according to the following procedure (use the keyboard on the C-729 / M-729 module or an attached terminal to set the configuration and control parameters):

1. Make sure that all modules are installed in the device.
2. Measure the input optical power with an optical power meter (it must be within the desired range).
3. Select AGC mode – on/off.
4. Connect the high frequency power meter to the output metering point (TP) and see if the gain and slope of signal is correct.
5. Adjust forward path amplification with attenuator (ATT).
6. Adjust slope with equalizer (EQU).
7. Check high frequency signal level for OUT1 and OUT2.
8. Make sure that 75 Ω terminators are affixed to unused outputs.

7. Technical parameters

7.1 Optical parameters

Input optical power range	dBm	-10...+1
AGC range	dBm	-6...0
Return loss	dB	≥ 40
Optical input wavelength	Nm	1100...1650
Maximum input power level	dBm	+2
Optical power measurement indication	-	3 x 7-sectional LED
Equivalent input noise current	pA/√Hz	6.5
Type of connectors	-	SC/APC

7.2 Forward path

Frequency range	MHz	47...862
Gain characteristic flatness	dB	±0.75
Output level (CENELEC 42) 1310nm@ -3dBm EQ =9 dB, 3,5% OMI, AGC OFF, CTB ≤ 60dBc, CSO ≤ 60dBc	dBuV	114
Interstage attenuator	dB	0...15 step 1
Interstage equalizer	dB	0...15 step 1
Test point	dB	20 ±1
Return loss at RF output	dB	18 (40MHz) -1,5dB / oct.

7.3 Other

Local powering	V/Hz	180...253/ 50-60
Power consumption	W	max 13.0
Output connectors	-	2*F
IP class	IP	24
Working temperature range	C	-20...55
Weight	kg	1.1
Dimensions	mm	107x155x75

7.4 MONITORED PARAMETERS (Read / Write)

Optical power input (Pin)	O/-
Optical inputs switching hysteresis (Pin min / Pin max)	O/C
Input selection (A / B / A preference / B preference)	O/C
RF output power (Pout)	O/-
RF output power alarm (RF min/ RF max)	O/C
Temperature (T)	O/C
Temperature alarm (T Min/ T Max)	O/C
Attenuator adjustment (A1)	O/C
Equalizer adjustment (E1)	O/C
Location (GPS coordinates)	O/C
AGC setting	O/C
Identification (type, model, SN, MAC)	O/-
ETH connection (IP, DHCP)	O/C
Power	O/-

Housing opened	O/-
----------------	-----

8. Service

This chapter is dedicated to fuse replacement procedure and installation and replacement procedures of the M-729 monitoring module.



Before commencing repair or installation, make sure that the device is disconnected from power supply! An electric shock can be a hazard for your life or health.



Replacing fuses in the MOB-729 optical receiver by user is not recommended. If a fuse blows, you should return the device to authorized service outlet. A blown fuse may be the result of a major defect.

8.1 Installing the C-729 local monitoring module.

To install the C-729 local monitoring module, you should plug the module into the appropriate ports - see figure 8.1.

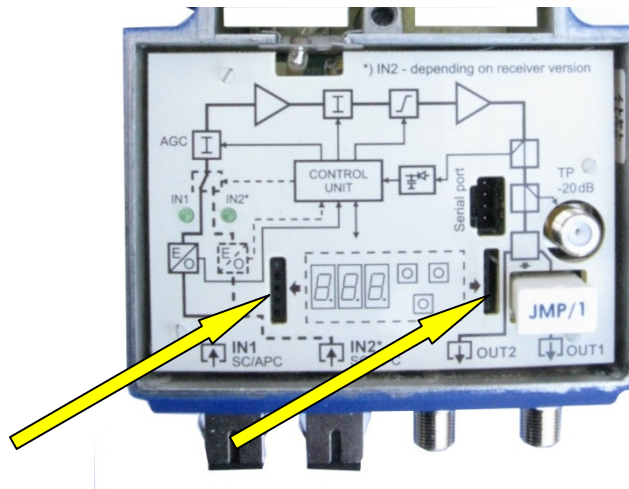

Fig. 8.1. Layout of plug-in ports for installing the local monitoring module.

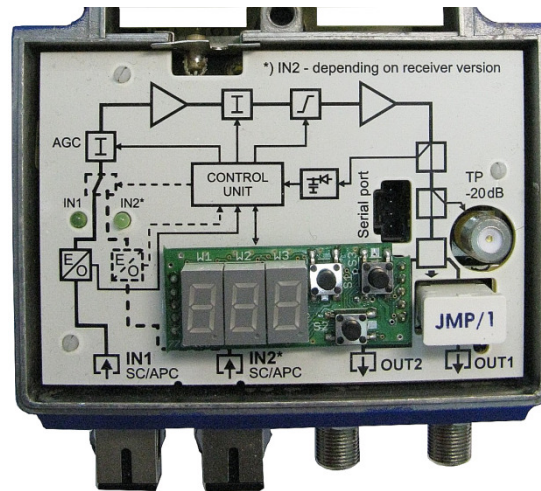

Fig. 8.2. View on the MOB-729 after installation of the C-729 local monitoring module.

8.2 Installing or replacing the M-729 remote monitoring module

To install or replace the remote monitoring module, open the optical node cover and follow the instructions below:

- remove the four screws attaching the power unit enclosure or the M-729 remote monitoring module, depending on factory fitted options - see fig. 8.3 and 8.4,

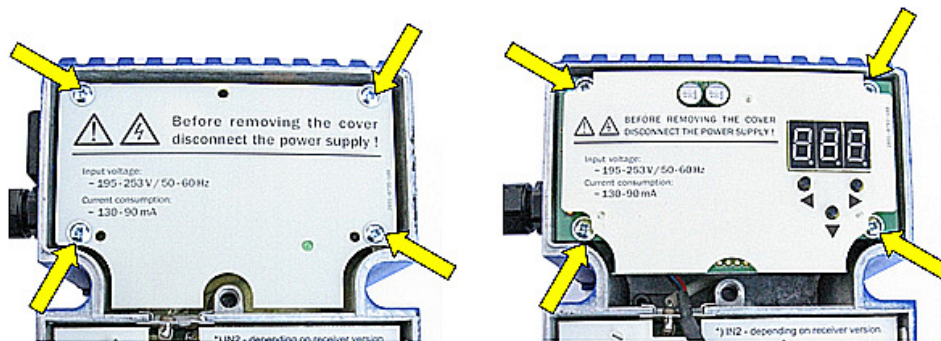

Fig. 8.3. Replacing the M-729 remote monitoring module - step 1.

- remove the M-729 remote monitoring module communication cable from the serial port - see the figure below (replacement of M-729 modules),

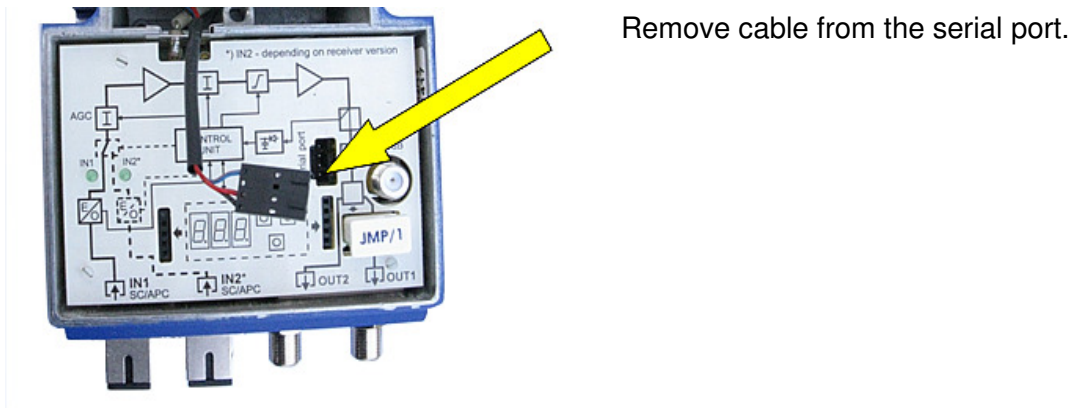
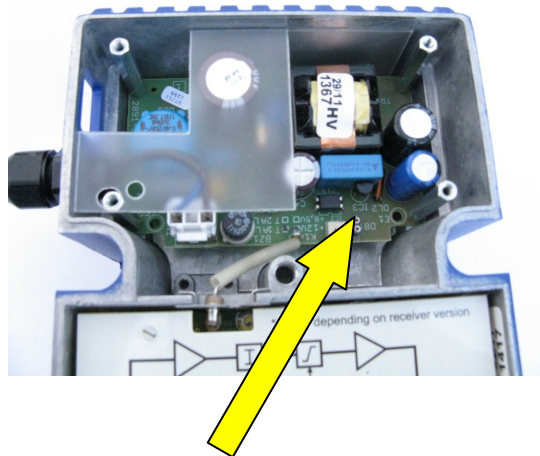

Fig. 8.4. Replacing the M-729 remote monitoring module - step 2.

- Remove the power pack cover and extract the LED. (for installation of the monitoring module). See the figure below:



- remove the power unit enclosure or the M-729 monitoring module, depending on factory fitted options. While removing the remote monitoring module, switch off its power supply through disconnecting - see fig. 8.5,



Disconnecting the remote monitoring module power cable.

Fig. 8.5. Replacing the M-729 remote monitoring module - step 3.

- if an insulation pad is missing, attach it according to fig. 8.6,

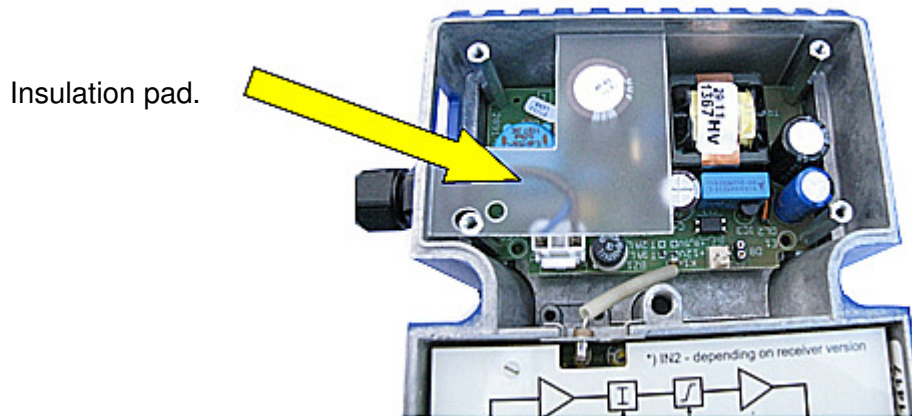
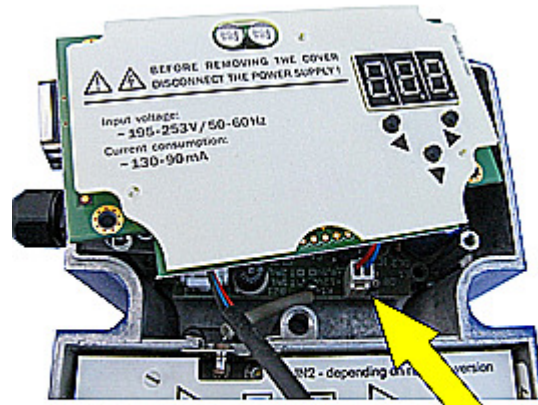

Fig. 8.6. Replacing the M-729 remote monitoring module - step 4.

- insert the M-729 remote monitoring module and switch on its power supply through inserting the socket on the cable into the contact on the power board - see fig. 8.7,



Insert the socket on the M-729 power cable

Fig. 8.7. Replacing the M-729 remote monitoring module - step 5.

- attach the monitoring module with four screws in the locations presented on fig. 8.8.

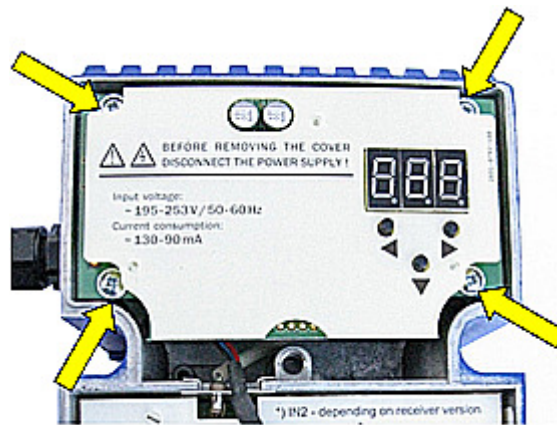

Fig. 8.8. Replacing the M-729 remote monitoring module - step 6.

- pull the communication cable precisely through the slot between the power unit section and the RF section, insert into the serial port.

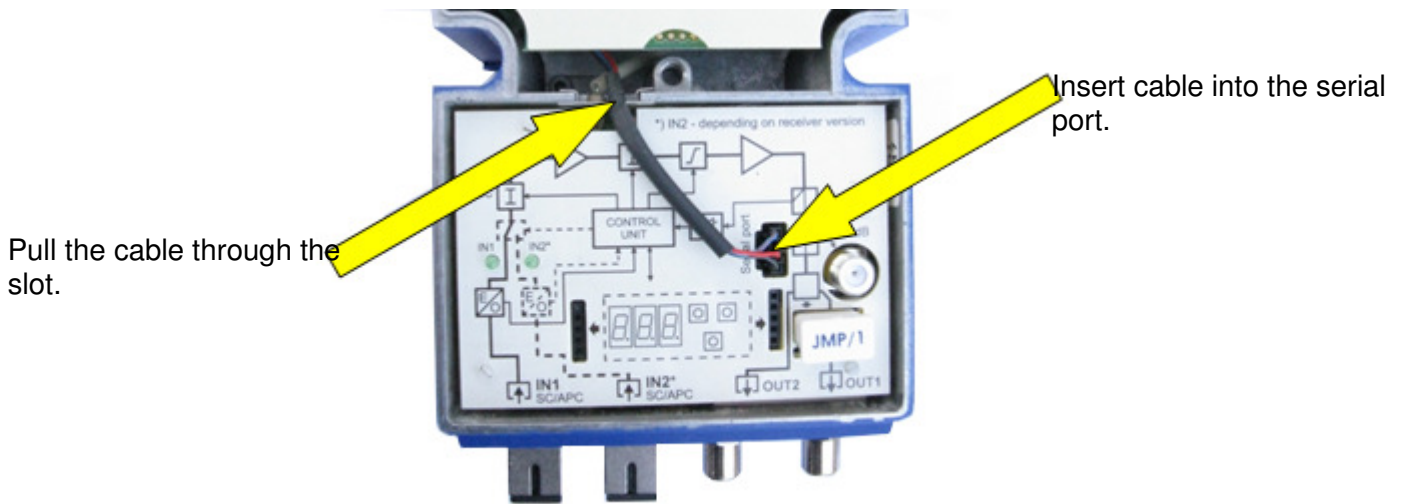

Fig. 8.9. Replacing the M-729 remote monitoring module - step 7.



Check correct grounding before connecting to power supply! An electric shock can be a hazard to your life or health.

8.3 Replacing a fuse in the power unit

To replace a fuse in the power unit, open the optical receiver cover and follow the instructions below:

- remove the four screws attaching the power unit enclosure or the M-729 remote monitoring module, depending on factory fitted options - see fig. 8.10,

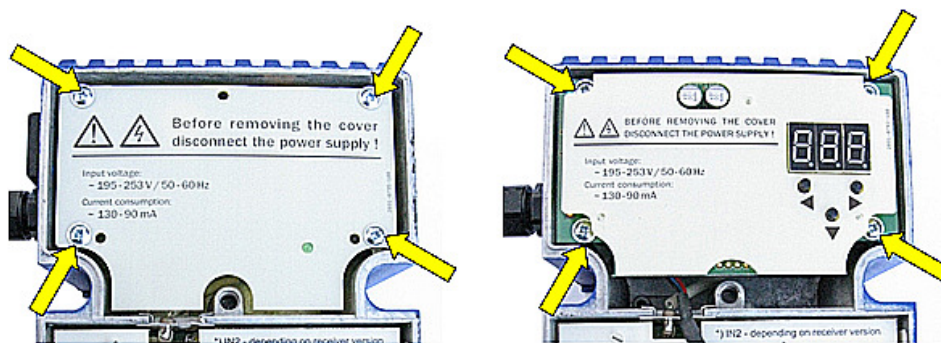

Fig. 8.10. Replacing a fuse in the MOB-729 - step 1.

- remove the M-729 remote monitoring module communication cable from the serial port - see fig. 8.11 (applicable to MOB-729 version with a remote monitoring module),

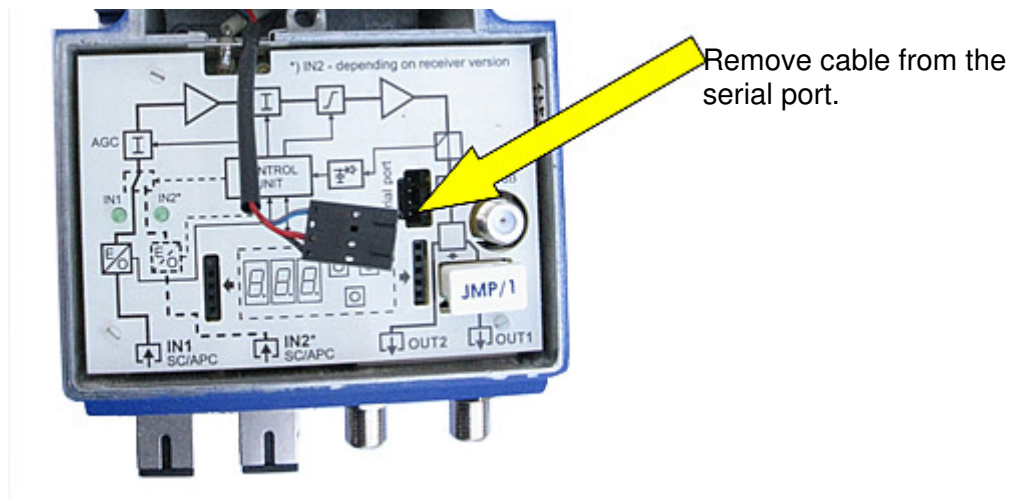

Fig. 8.11. Replacing a fuse in the MOB-729 - step 2.

- remove the power unit enclosure or the M-729 monitoring module, depending on factory fitted options. While removing the remote monitoring module, switch off its power supply through disconnecting - see fig. 8.12,

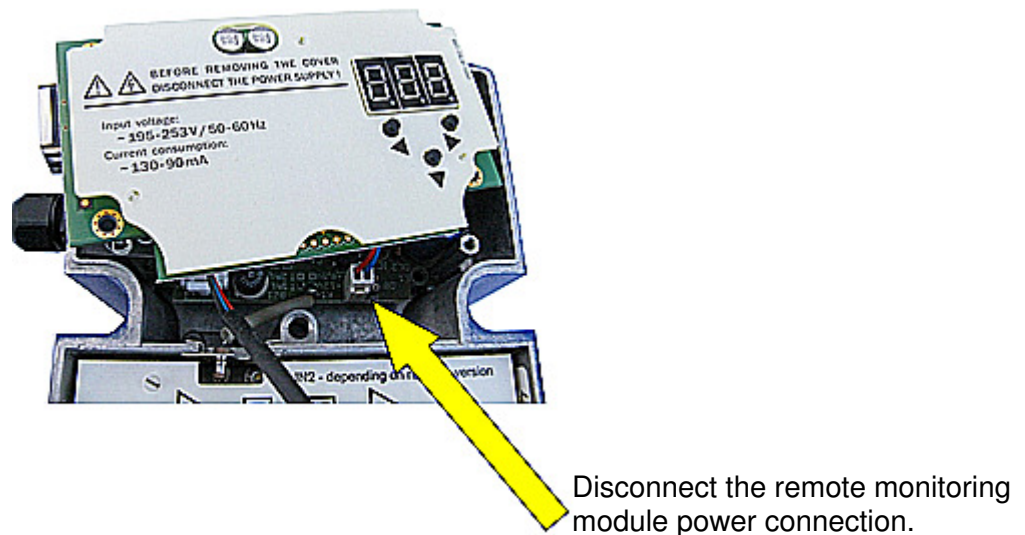

Fig. 8.12. Replacing a fuse in the MOB-729 - step 3.

- remove the insulation pad (applicable to MOB-729 with a remote monitoring module),

Insulation pad.

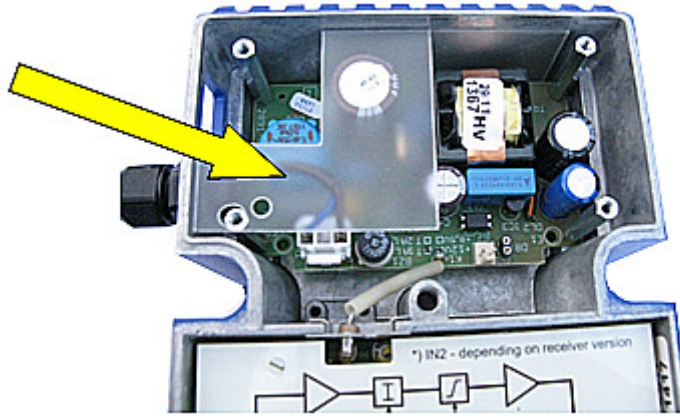

Fig. 8.13. Replacing a fuse in the MOB-729 - step 4.

- replace the fuse - see figure 8.14. Remember that the protection current type and value must be identical to those of the original fuse –T1A 250V.

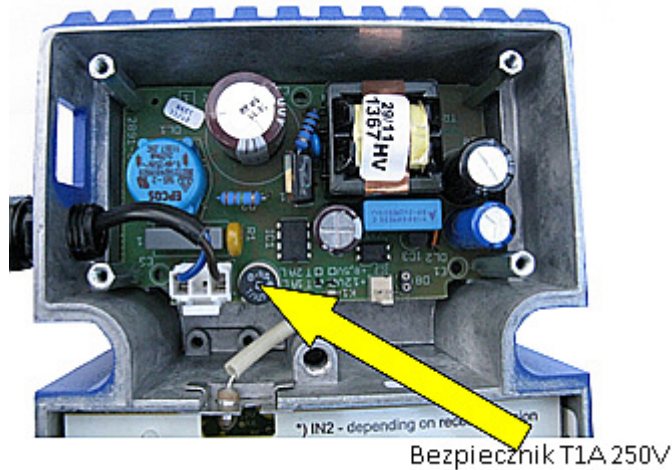

Fig. 8.14. Replacing a fuse in the MOB-729 - step 5.

- mount and attach the power unit cover (applicable to MON-729 without remote monitoring) or insert the insulation pad, insert the monitoring module and connect its power supply, then attach the monitoring module with four screws. Pull the communication cable precisely through the slot between the power unit section and the RF section, insert into the serial port.



Check correct grounding before connecting to power supply! An electric shock can be a hazard to your life or health.

9. Markings

MOB-729/X/X

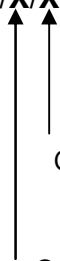

Controls: **M** – remote monitoring module, **C** – local monitoring module

Optical inputs: **1** – one, **2** - two

10. Technical support

If you did not find the necessary information or answers to any additional questions in this manual, please contact us via e-mail at:
handlowy@telmor.pl.

11. List of drawings

- Fig. 3.1. Block diagram of the MOB-729 optical receiver.
- Fig. 3.2. MOB-729/2 optical receiver.
- Fig. 3.3. MOB-729/2/M optical receiver.
- Fig. 3.4. Power unit view.
- Fig. 3.5. C-729 local monitoring module.
- Fig. 3.6. M-729 remote monitoring module.
- Fig. 3.7. JMP/1 – jumper module.
- Fig. 3.8. STI-3,5 module.
- Fig. 3.9. TSI module – 2/6.
- Fig. 4.1. View on the housing of the MOB-729 optical receiver.
- Fig. 5.1. Interior of the MOB-729 optical receiver with a C-729 local monitoring module.
- Fig. 5.2. Interior of the MOB-729 optical receiver with an M-729 remote monitoring module.
- Fig. 5.3. JMP/1, STI-3,5 or TSI module port in the MOB-729 optical receiver.
- Fig. 5.4. Local electronic adjustment of the MOB-729/1/M – menu tree 1.
- Fig. 5.5. Local electronic adjustment of the MOB-729/1/M – menu tree 2.
- Fig. 5.6. LED indication of the MOB-729 optical receiver.
- Fig. 5.8. LED indication of the MOB-729 optical receiver.
- Fig. 5.9. LED indication of the MOB-729 optical receiver.
- Fig. 5.10. LED indication of the MOB-729 optical receiver.
- Fig. 5.11. LED indication of the MOB-729 optical receiver.
- Fig. 5.12. LED indication of the MOB-729 optical receiver.
- Fig. 5.13. LED indication of the MOB-729 optical receiver.
- Fig. 5.14. LED indication of the MOB-729 optical receiver.
- Fig. 5.15. LED indication of the MOB-729 optical receiver.
- Fig. 5.16. Web interface - welcome page.
- Fig. 5.17. Defining users.
- Fig. 5.18. Configuration tab.
- Fig. 5.19. Maximum setpoint exceeded.
- Fig. 5.20. Configuration tab.
- Fig. 5.22. Firmware Upload tab.
- Fig. 5.22. Administration tab.
- Fig. 5.23. SNMP tab.
- Fig. 5.24. About tab.
- Fig. 8.1. Layout of plug-in ports for installing the local monitoring module.
- Fig. 8.2. View on the MOB-729 after installation of the C-729 local monitoring module.
- Fig. 8.3. Replacing the M-729 remote monitoring module - step 1.
- Fig. 8.4. Replacing the M-729 remote monitoring module - step 2.
- Fig. 8.5. Replacing the M-729 remote monitoring module - step 3.
- Fig. 8.6. Replacing the M-729 remote monitoring module - step 4.
- Fig. 8.7. Replacing the M-729 remote monitoring module - step 5.
- Fig. 8.8. Replacing the M-729 remote monitoring module - step 6.
- Fig. 8.9. Replacing the M-729 remote monitoring module - step 7.
- Fig. 8.10. Replacing a fuse in the MOB-729 - step 1.
- Fig. 8.11. Replacing a fuse in the MOB-729 - step 2.
- Fig. 8.12. Replacing a fuse in the MOB-729 - step 3.
- Fig. 8.13. Replacing a fuse in the MOB-729 - step 4.
- Fig. 8.14. Replacing a fuse in the MOB-729 - step 5.